

4 PORT 0°/180° HYBRID CONNECTORIZED: KSJ-K5

500 - 2200 MHz

FEATURES:

- ▶ Wide Bandwidth
- ▶ Closely Controlled Phase/Amplitude Unbalance
- ▶ RoHS Compliant



SPECIFICATIONS

Frequency	500 - 2200 MHz		
Insertion Loss *	I/O	dB (Typ.)	dB (Max.)
	Σ to C/D	0.9	1.7
	Δ to C/D	1.25	2.2
Amplitude Unbalance	Frequency (MHz)	dB (Max.)	
	500-2200	0.75	
	750-2170	0.5	
Phase Unbalance	Frequency (MHz)	Deg. (Max.)	
	500-2200	7°	
	750-2170	5°	
Isolation (dB)	I/O	Typ.	Min.
	Σ to Δ	35	18
	C to D	18	10
Input Power Rating	150 mWatt (Max.)		
Impedance	50 Ohms (Nom.)		
VSWR	1.5:1 (Max.)		
Operating Temperature Range	-40 to +85 °C		
<i>* Above 3 dB split loss.</i>			

Package # 113LF

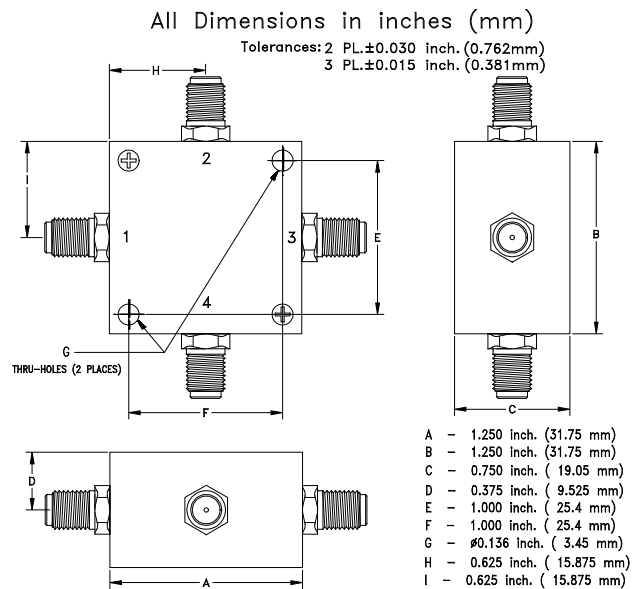

PORT IDENTIFICATION

Sum (Σ)	Delta (Δ)	0° Output (C)	0°/180° Output (D)
1	4	3	2

For 3 port operation, terminate either Σ or Δ input into 50 Ohms.

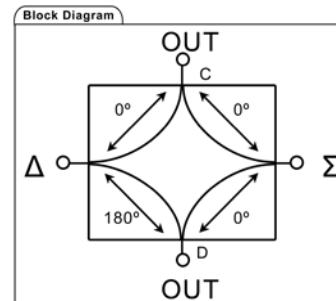

4 PORT 0/180° HYBRID CONNECTORIZED: KSJ-K5

500 - 2200 MHz

Data @ 25°C

PERFORMANCE PLOTS

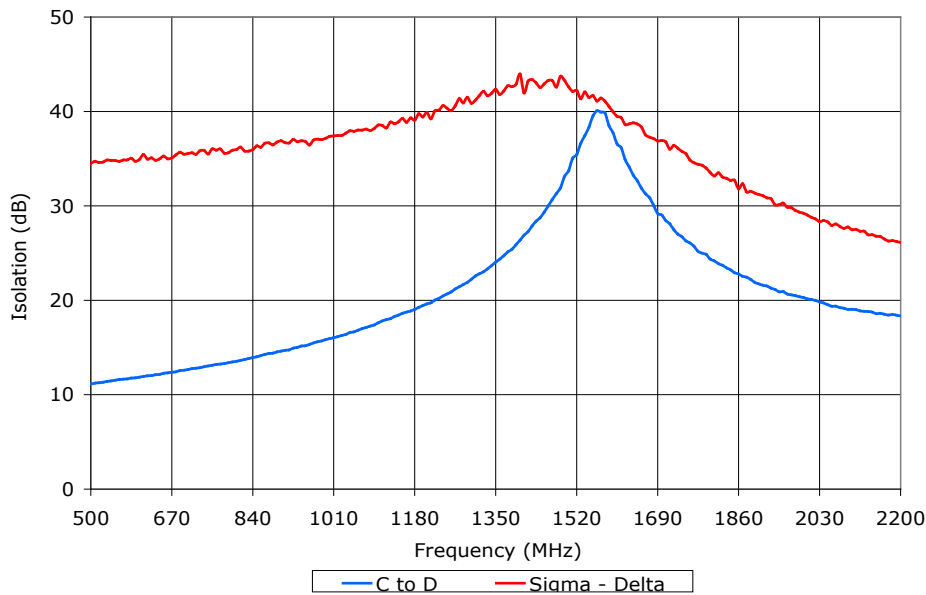
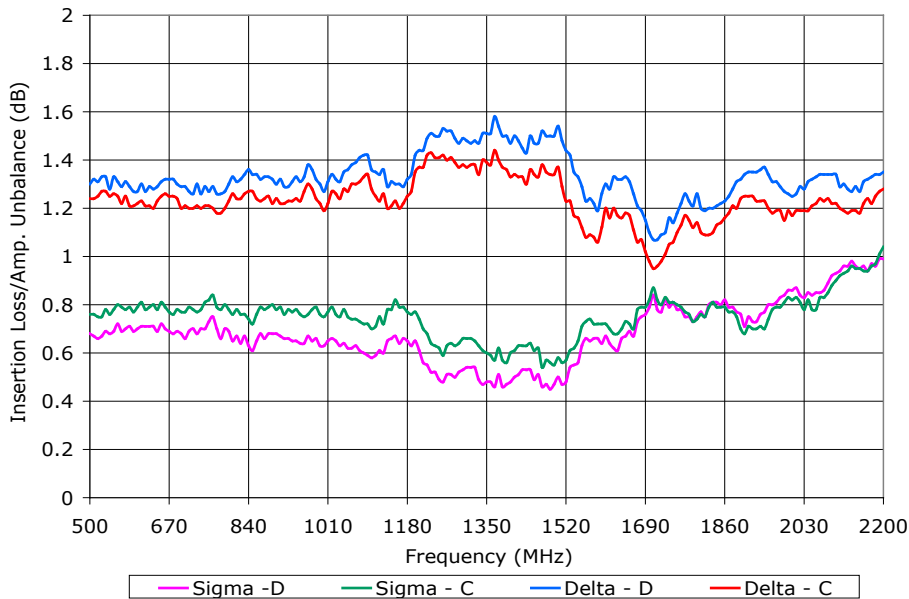

4 PORT 0/180° HYBRID CONNECTORIZED: KSJ-K5

500 - 2200 MHz

Data @ 25°C

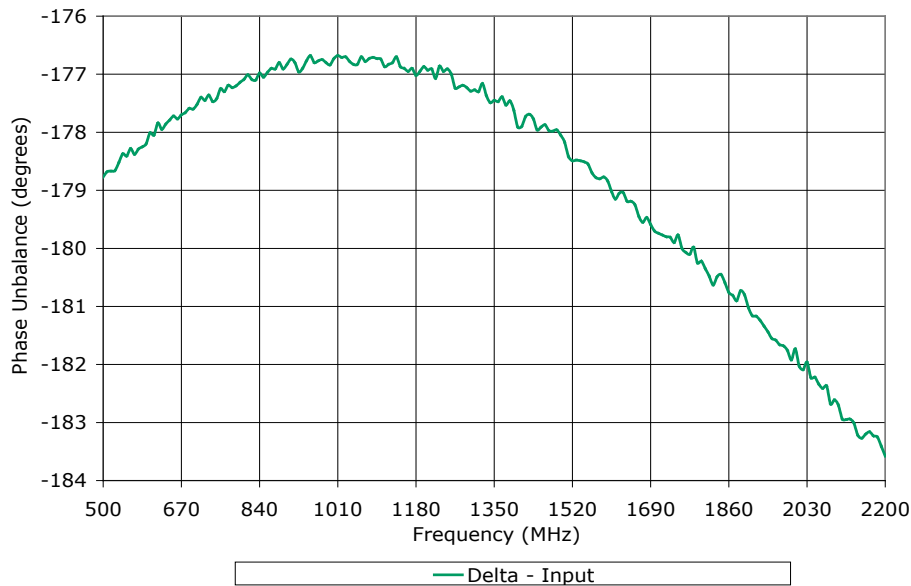
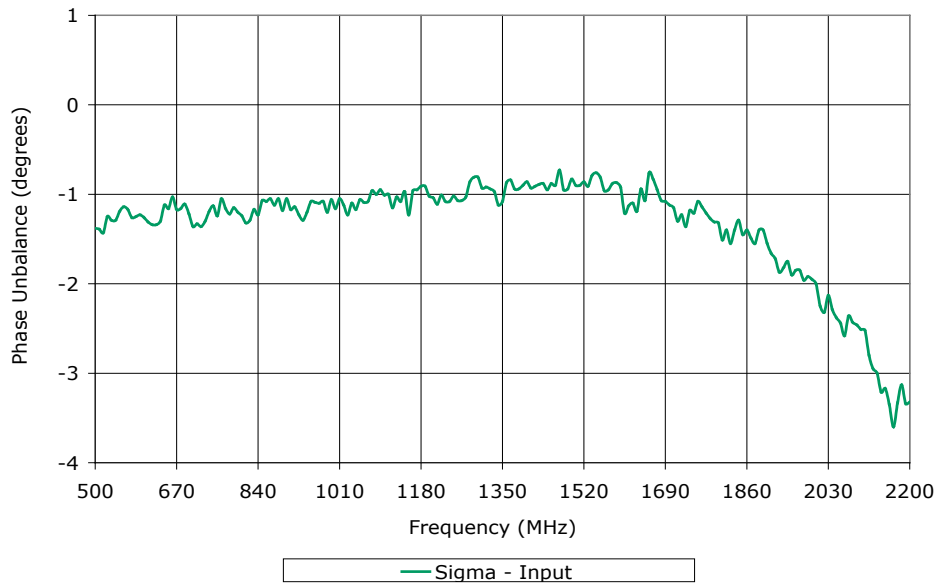

PERFORMANCE PLOTS

4 PORT 0/180° HYBRID CONNECTORIZED: KSJ-K5

500 - 2200 MHz

Data @ 25°C

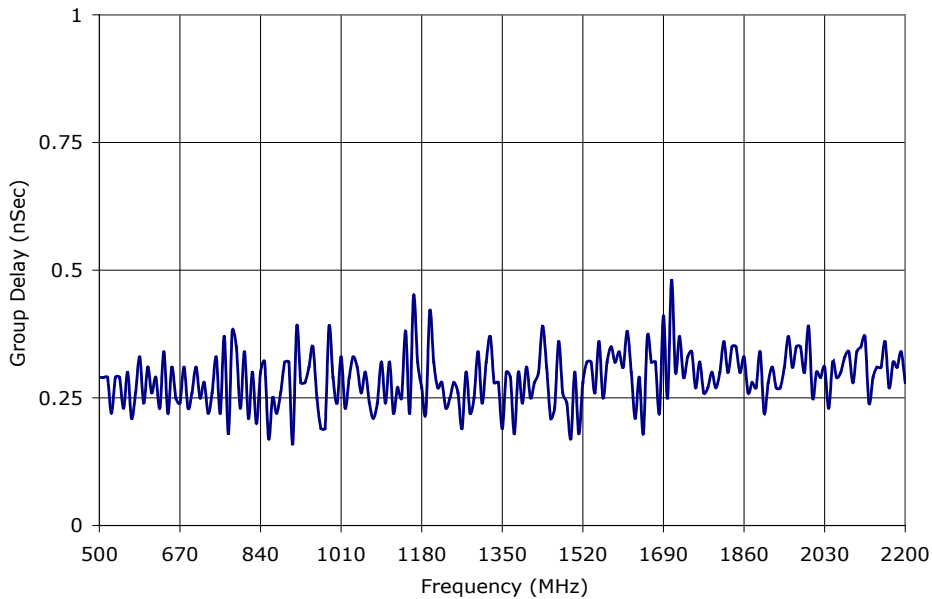
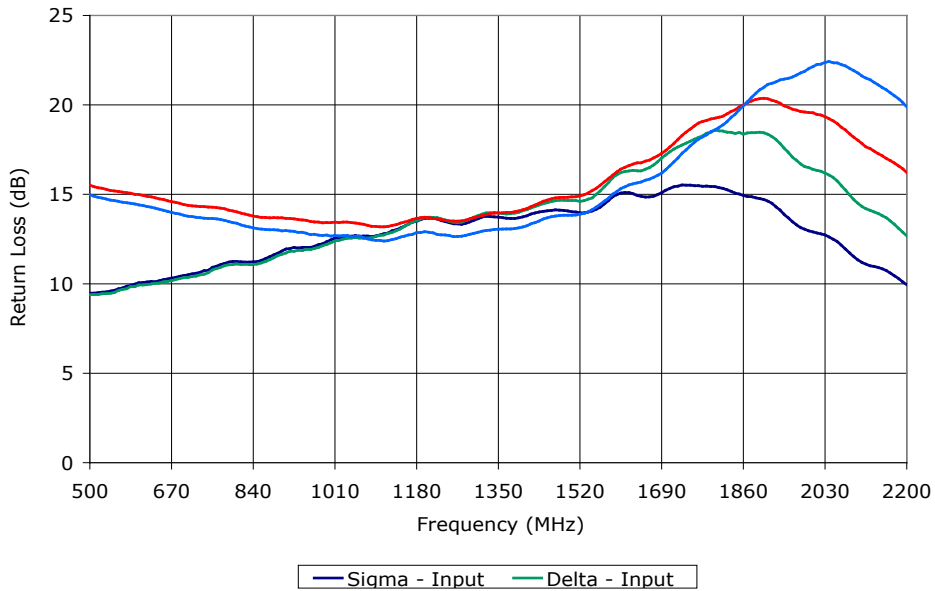

PERFORMANCE PLOTS