

# 2-WAY POWER DIVIDER

## SURFACE MOUNT MODEL: DSK-726S

WIDE BANDWIDTH

5 - 2000 MHz

**FEATURES:**

- ▶ Excellent Performance
- ▶ Wide Bandwidth
- ▶ Small Size
- ▶ Applications: Signal Splitting & Low Power Combining
- ▶ Lead Free RoHS Compliant

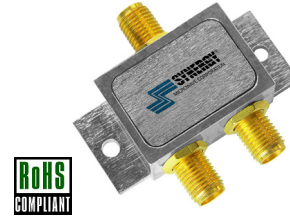

SPECIFICATIONS (Rev. C 03/12/07)

<b>Frequency</b>	5 - 2000 MHz		
<b>Insertion Loss *</b>	Freq. (MHz)	dB (Typ.)	dB (Max.)
	5-50	0.6	0.9
	50-1000	0.9	1.4
	1000-2000	1.5	1.9
<b>Isolation</b>	Freq. (MHz)	dB (Typ.)	dB (Min.)
	5-50	25	20
	50-1000	28	20
	1000-2000	28	15
<b>Phase Unbalance</b>	Freq. (MHz)	Degrees (Max.)	
	5-50	2	
	50-1000	3	
	1000-2000	5	
<b>Amplitude Unbalance</b>	Freq. (MHz)	dB (Max.)	
	5-50	0.2	
	50-1000	0.3	
	1000-2000	0.4	
<b>VSWR</b>	1.25:1 (Typ.)		
<b>Input Power</b>	1 Watt (Max.)		
<b>Output Impedance</b>	50 Ohms (Nom.)		
<b>Operating Temperature Range</b>	-55 to +85 °C		
* Above 3 dB split loss.			

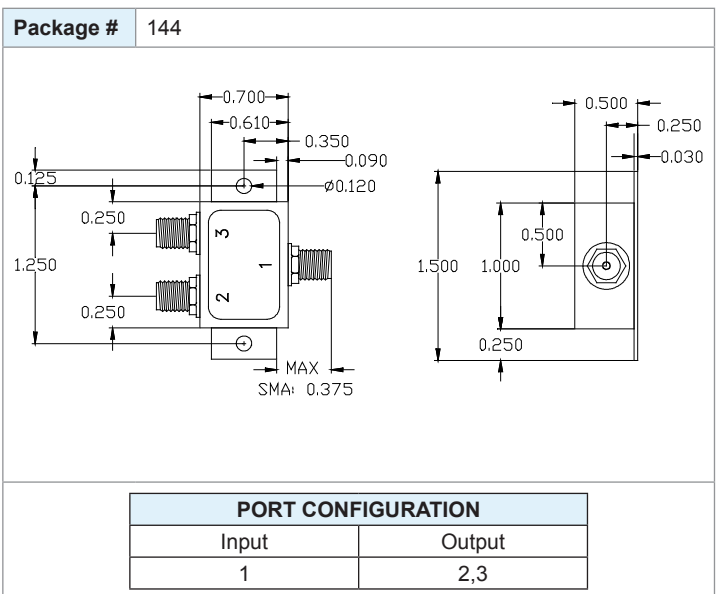

# 2-WAY POWER DIVIDER

## SURFACE MOUNT MODEL: DSK-726S

WIDE BANDWIDTH

5 - 2000 MHz

Data @ 25°C

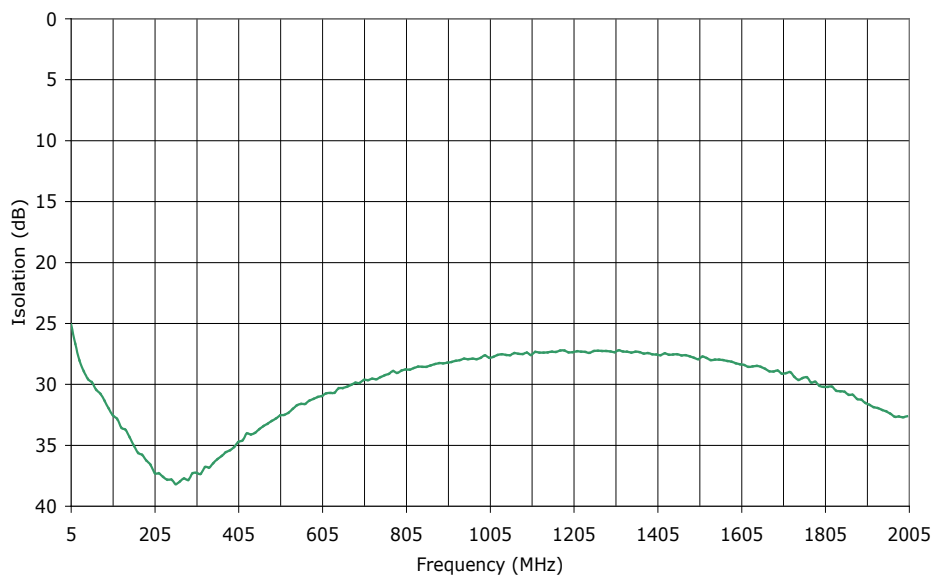
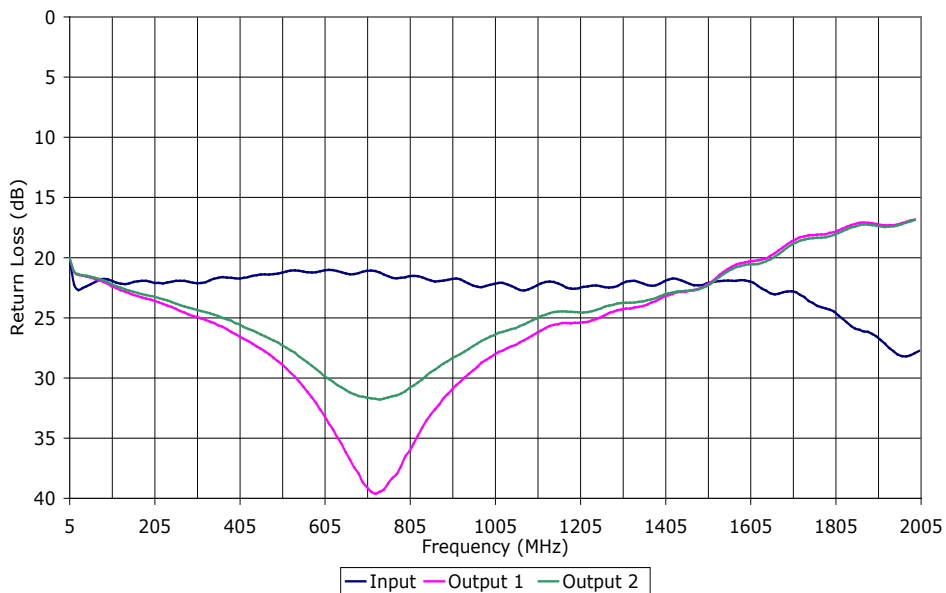

PERFORMANCE PLOTS

# 2-WAY POWER DIVIDER

## SURFACE MOUNT MODEL: DSK-726S

WIDE BANDWIDTH

5 - 2000 MHz

Data @ 25°C

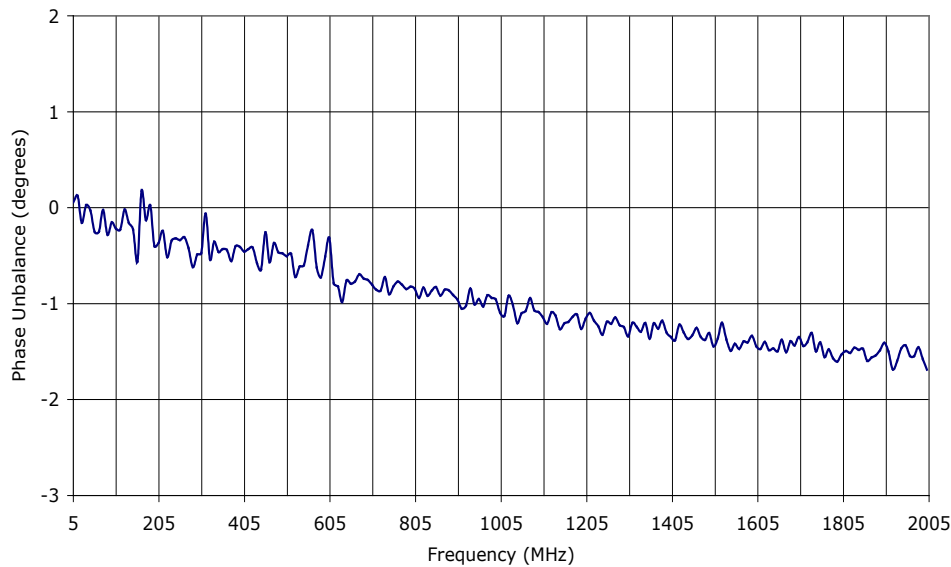

add note above 3 dB split loss

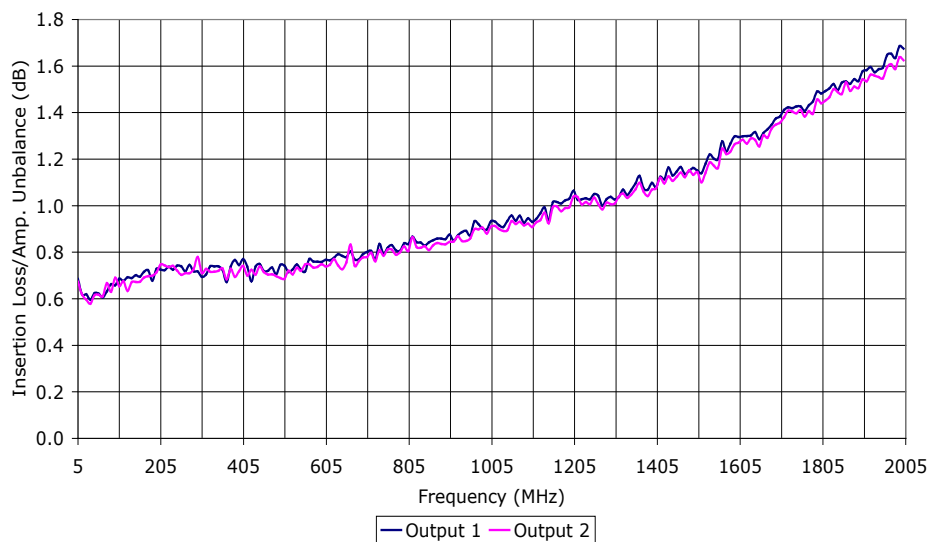

PERFORMANCE PLOTS

# 2-WAY POWER DIVIDER

## SURFACE MOUNT MODEL: DSK-726S

WIDE BANDWIDTH

5 - 2000 MHz

Data @ 25°C

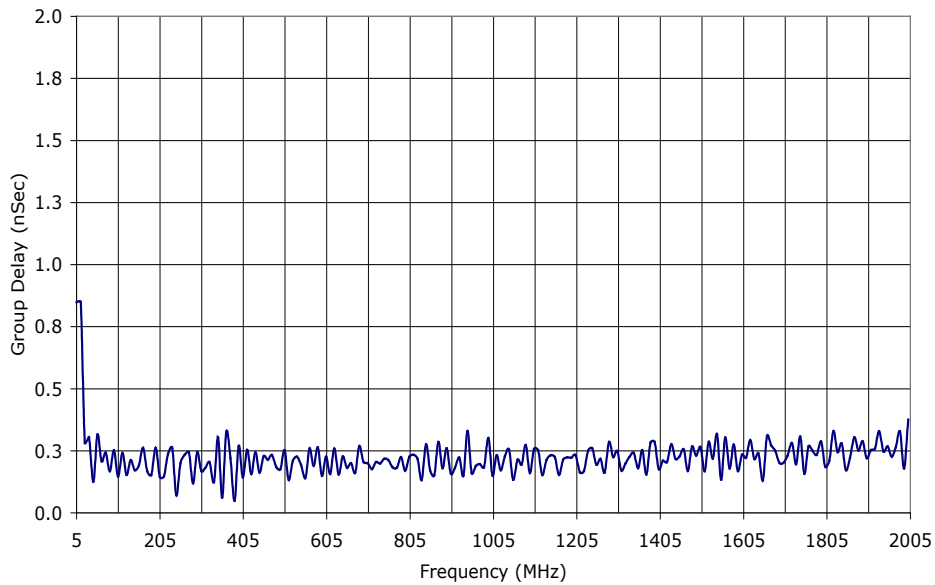

PERFORMANCE PLOTS