

TRIPLE-BALANCED MIXER

CONNECTORIZED MODEL: CLK-3500

WIDE BANDWIDTH

10 - 3500 MHz

FEATURES:

- ▶ High Performance
- ▶ High Interport Isolation
- ▶ Broad Bandwidth IF
- ▶ Good IF Matching
- ▶ Flat Conversion Loss Response

APPLICATIONS:

- ▶ Narrow Band & Broadband Up/Down Conversion.

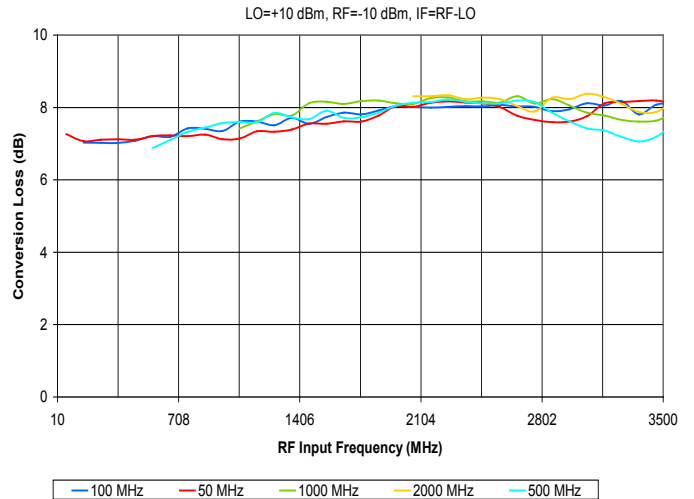

SPECIFICATIONS (Rev. C 12/02/10)

Frequency	RF/LO (MHz)	IF (MHz)	
	10 - 3500	1 - 2000	
Conversion Loss	dB (Typ)		dB (Max)
	8		9
Isolation		dB (Typ)	dB (Min)
	LO/RF	40	25
	LO/IF	28	18
	RF/IF	30	20
L.O. Power	+10 dBm (Nom)		
1 dB Compression Point	+7 dBm (Typ)		
Input IP ³	+19 dBm (Typ)		
Impedance	50 Ohms (Nom)		
Operating Temperature Range	-55 to +85 °C		

Package # 110LF

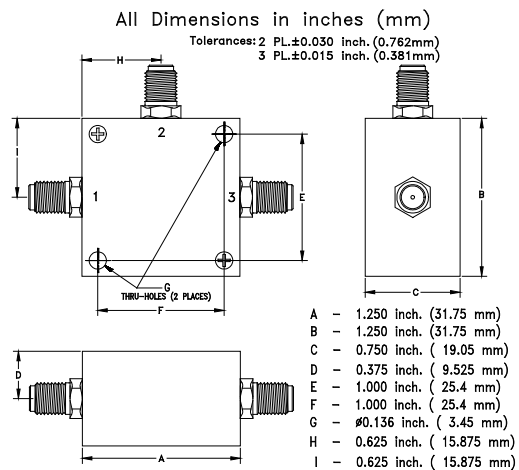

PORT CONFIGURATION

RF	LO	IF
1	3	2

TRIPLE-BALANCED MIXER

CONNECTORIZED MODEL: CLK-3500

WIDE BANDWIDTH

10 - 3500 MHz

PERFORMANCE PLOTS

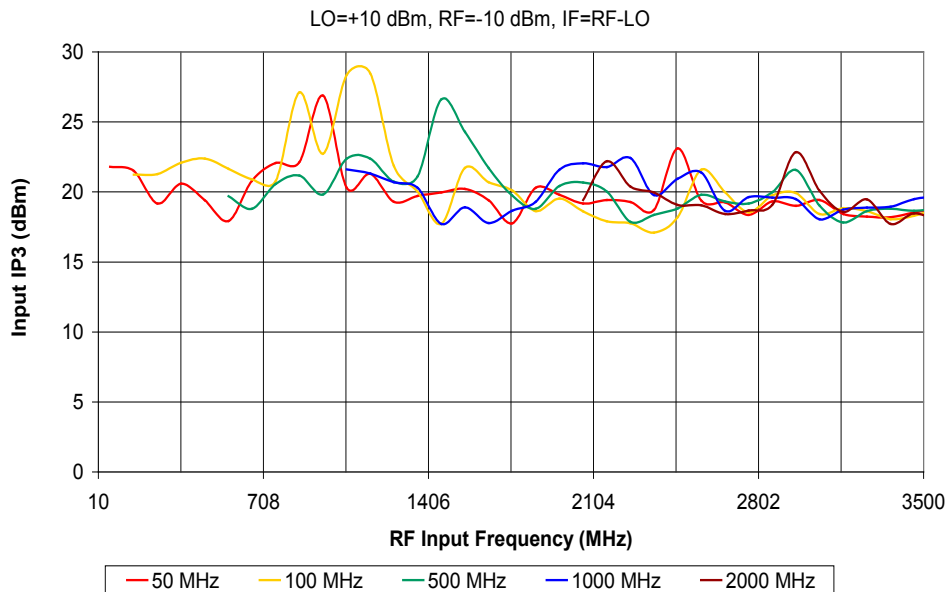
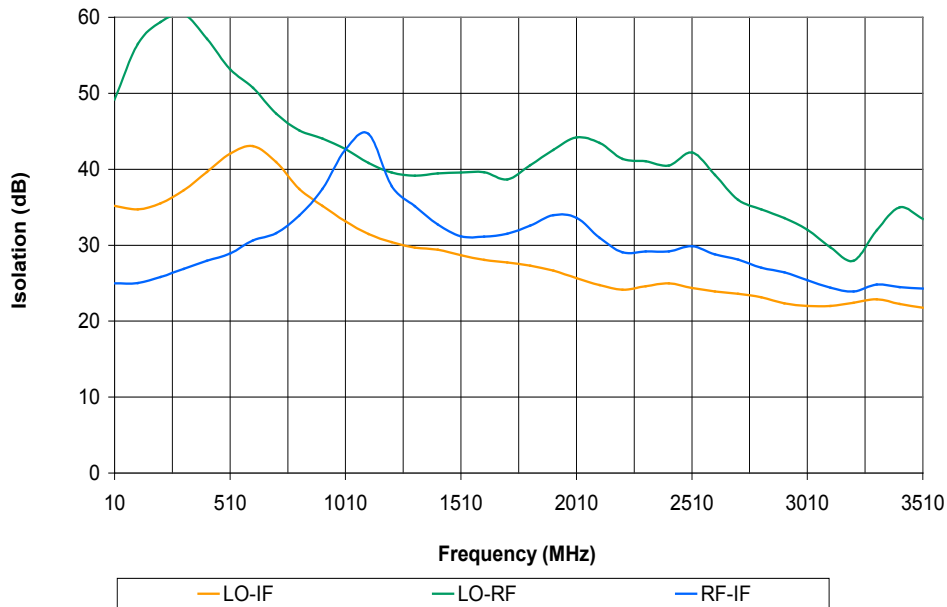

TRIPLE-BALANCED MIXER

CONNECTORIZED MODEL: CLK-3500

WIDE BANDWIDTH

10 - 3500 MHz

PERFORMANCE PLOTS

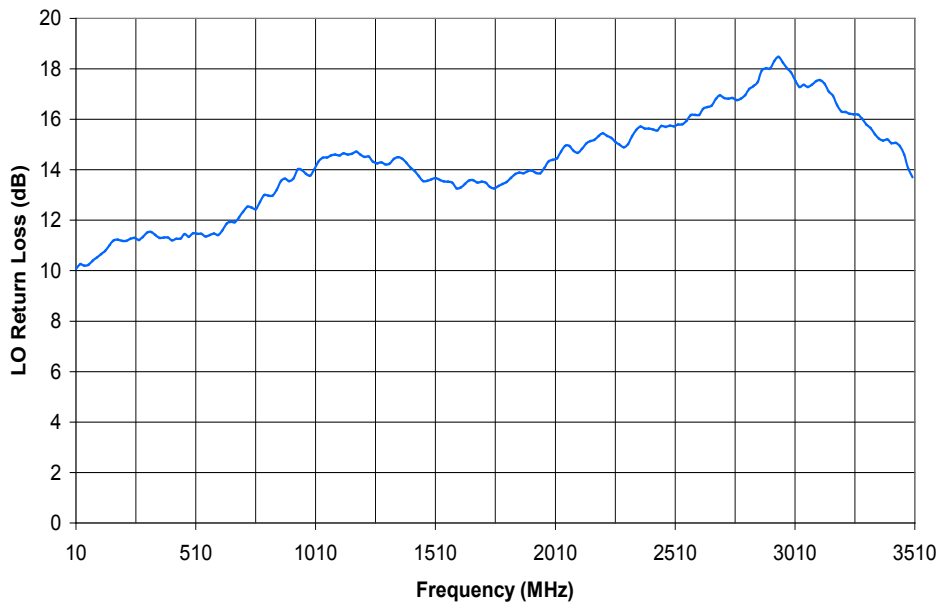
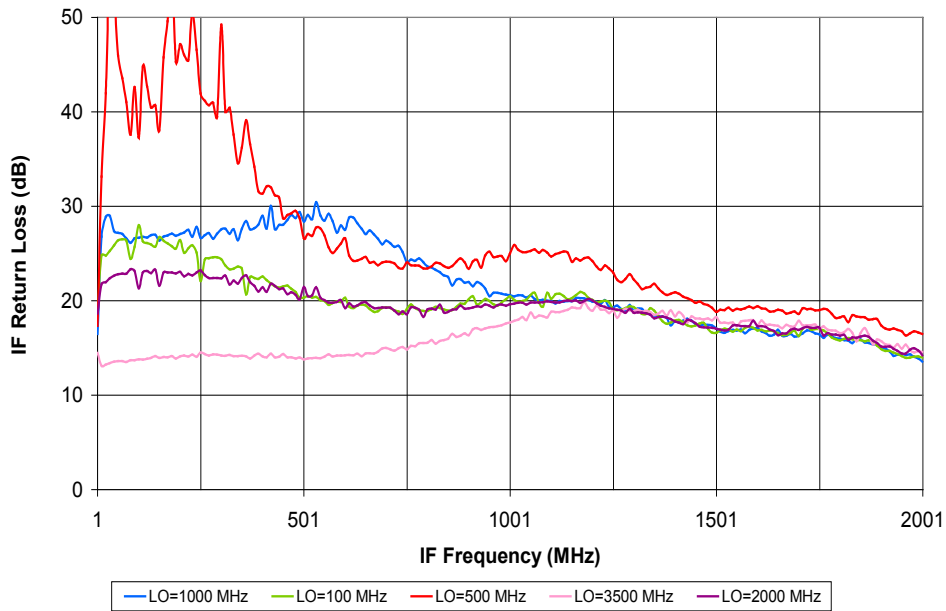

TRIPLE-BALANCED MIXER

CONNECTORIZED MODEL: CLK-3500

WIDE BANDWIDTH

10 - 3500 MHz

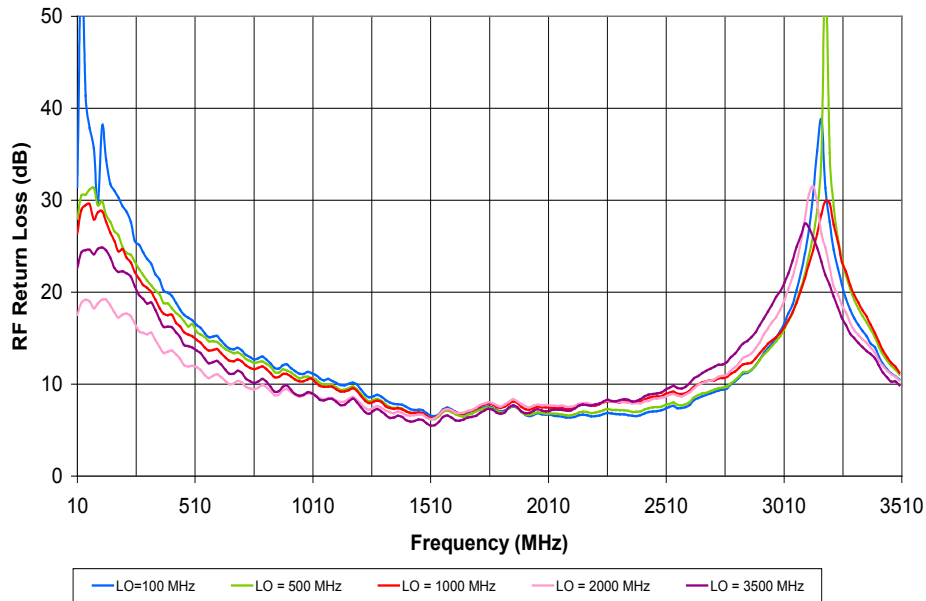

PERFORMANCE PLOTS